

TRADITIONAL® PREST® BRICK

Nominal 6" x 12"

5 7/8" x 11 3/4"

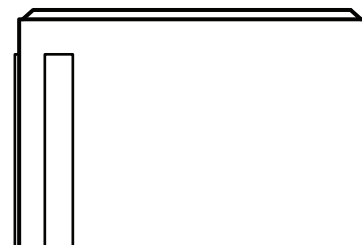
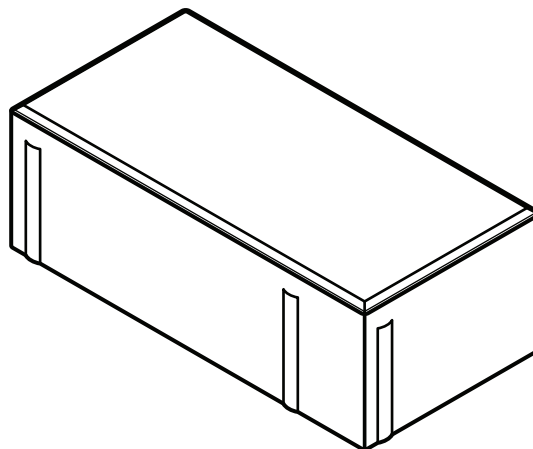
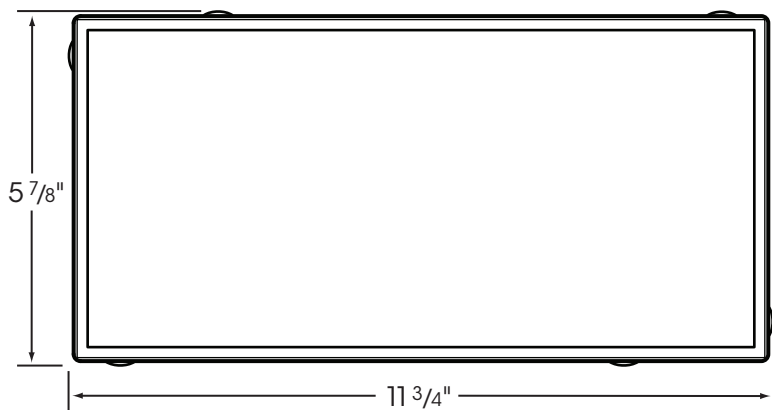

Please Note: 6" x 12" shown with 4" thickness. 2 3/8" and 3" thicknesses are also available.
 Sizes shown are nominal. Products are made to fit metric modules.
 Overall dimensions include one spacer.

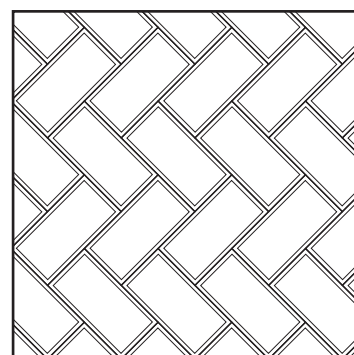
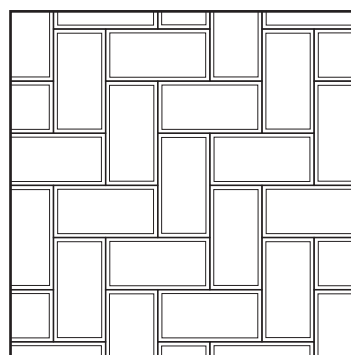
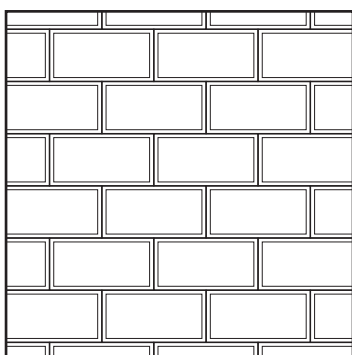
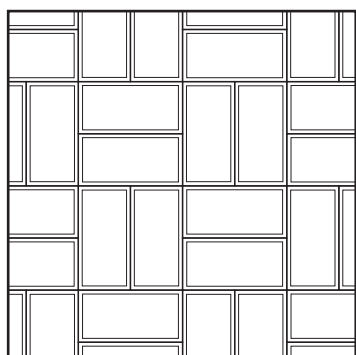

Basketweave Pattern

Running Bond Pattern

90° Herringbone

45° Herringbone

Please Note: The two patterns shown above, the Basketweave and Running Bond Patterns, are suggested for pedestrian use only.

Please Note: The two patterns shown above, the 90° Herringbone and the 45° Herringbone Patterns, are suggested for low speed, low volume, vehicular traffic.

HANOVER[®]
Architectural Products
 5000 Hanover Road, Hanover, PA 17331
 717.637.0500 fax 717.637.7145
www.hanoverpavers.com